

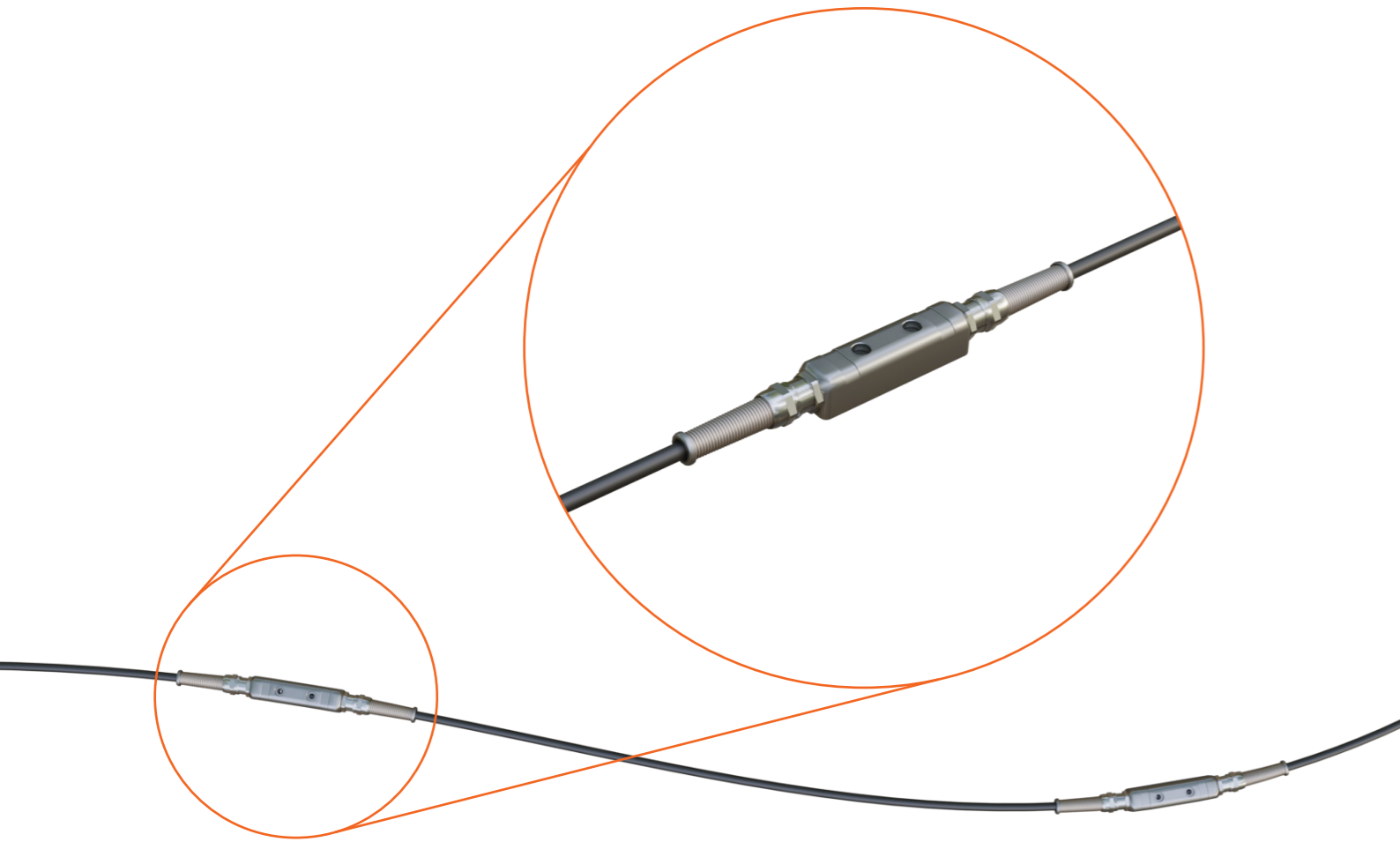

## The Osprey Tilt String (OTS) Product Data Sheet

Distributed tilt sensing array designed for versatility and ease of use.



## FEATURES

- Full 360 degree range on all axes.
- Miniature design for low profile installations.
- Reinforced thru-holes for bolting direct to structures or secondary mounting brackets.
- Banding strap recesses for secure fixing to reinforcement bars, support rods or inclinometer casing/access pipe.
- Rugged stainless steel housing fit for the construction environment.
- Corrosion resistant and ingress protected to 12 Bar.
- Option for Kevlar reinforced cable or flexible steel conduit for ultimate cable protection.
- Available at 0.5m, 1m, 3m or 5m intervals.
- Wide range of mounting bracket options available.

## APPLICATIONS



### Rail

- Track mounted for longitudinal settlement profile.
- Sleeper mounted for transverse rotation (cant/ twist).

# The Osprey Tilt String (OTS)

## DESCRIPTION

The Osprey Tilt String (OTS) is a distributed tilt sensing array designed for versatility and ease of use. The system comprises a series of tilt sensors, regularly spaced along a single cable bus.

Each tilt sensor utilises a high precision triaxial accelerometer to provide rotational measurement in any orientation to a high degree of accuracy.

The system is designed to be well suited to a broad range of structural and geotechnical applications, either surface mounted on steel, concrete, wood, or masonry, or directly embedded in concrete, grout, or soil.

A variety of mounting options enables rapid deployment in any application, and the system's single cable bus and low power consumption allows simple connection of large numbers of sensors with a single battery powered digital datalogger. This minimises maintenance requirements and simplifies data management.

### Retaining Walls

- Aligned vertically for lateral deformation profile.
- Aligned horizontally for distributed rotational monitoring.

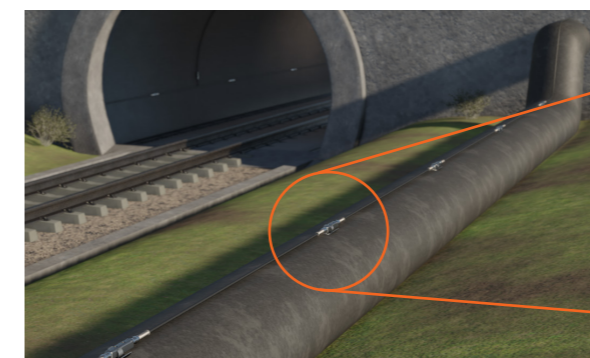
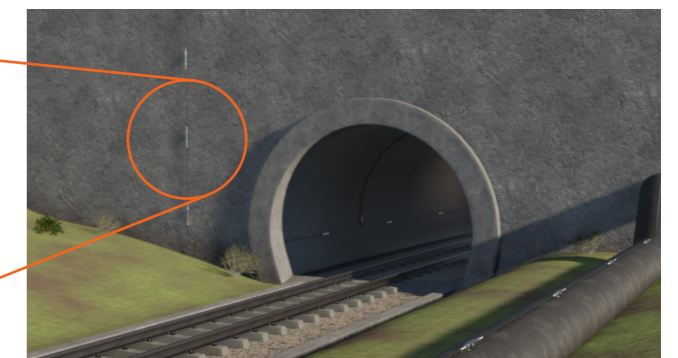
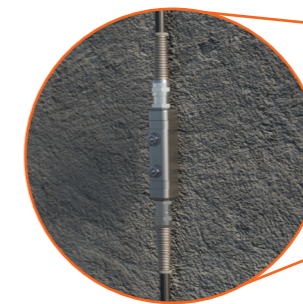

### Pipelines

- Affixed with magnets or welding plates.
- Suitable for either above or below ground applications.

## APPLICATIONS

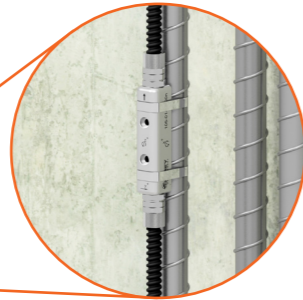

### Deep Excavation

- Embedded within diaphragm walls or floor slabs.
- Magnetically attached to sheet pile walls.

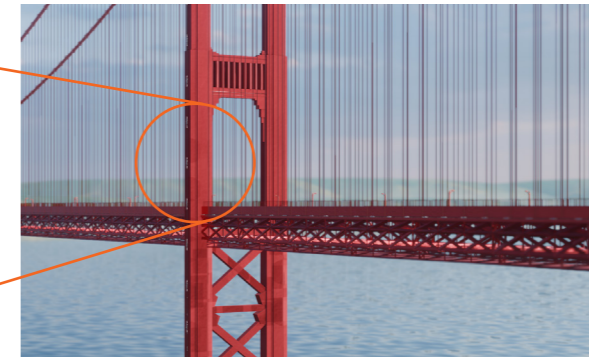
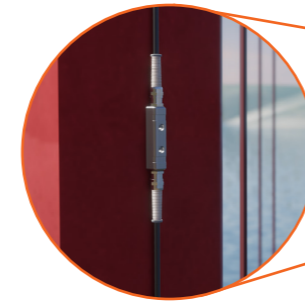

### Bridges

- Capture full profile of bridge piers, towers, or decks.
- Synchronous setting allows simultaneous measurement at all points to capture a complete snapshot of dynamic structures.

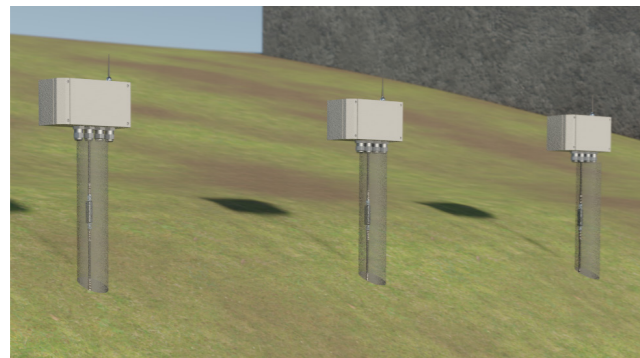

### Slopes

- Installed within a trench or on ground stakes for wide area coverage and early failure warning.
- Mounted on inclinometer casing for automated alerts with optional manual surveys.

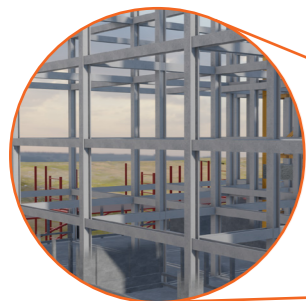

### High Rise Towers

- Embedded within lift cores, columns or floor slabs during construction.
- Surface mounted on existing columns, facades or tower core.

## MOUNTING OPTIONS



### Rail Clip

For low profile longitudinal settlement profile of rails. Mounted in the web of the rail, safe from rail maintenance operations.

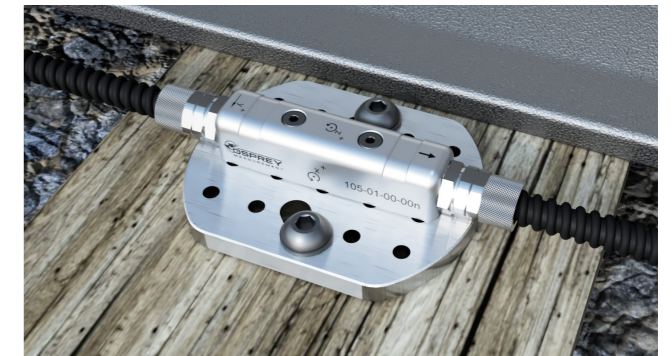

### Mounting Bracket

For concrete, masonry, steel or wood using anchors, screws or adhesives. Arc weldable for robust mounting option for steel, while allowing easy retrieval of the devices.

### Tunnels

- Longitudinal settlement profile or convergence.
- Mounting options include wall anchors or adhesives for concrete or masonry, magnets for steel supports, or direct embedment within shotcrete lining.



### Fixing Straps

For fixing to reinforcement cages, inclinometer casing, access tube etc. for direct embedment applications.

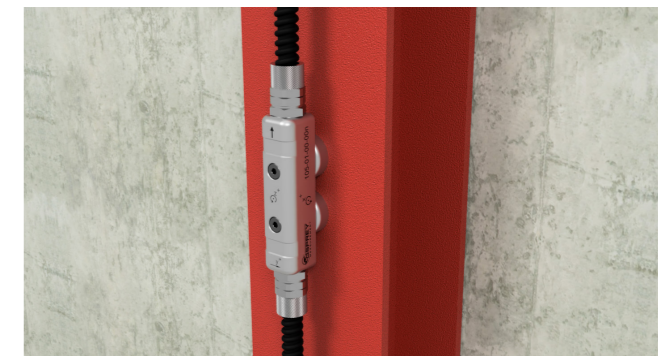

### Magnets

For rapid deployment on steel: rail, pipelines, gantries, bridges, tunnels, struts, girders etc.

## COMPONENTS

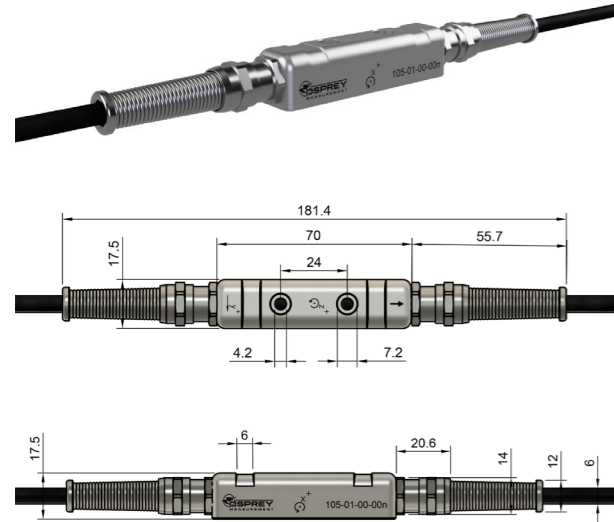

Osprey Tilt String with Kevlar Reinforced Cable

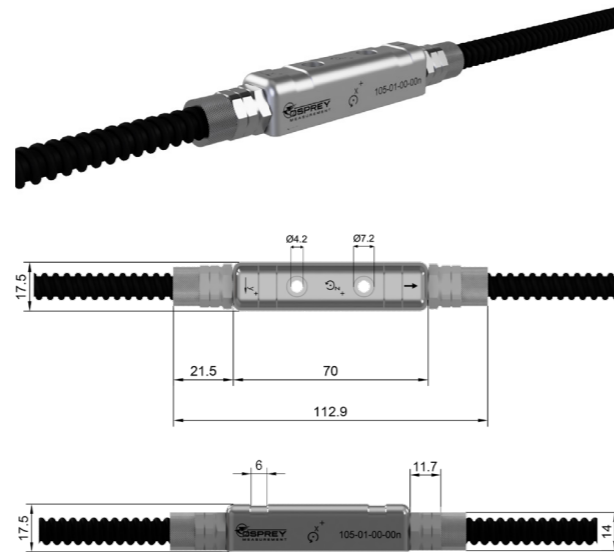

Osprey Tilt String with Flexible Conduit

## ACCESSORIES

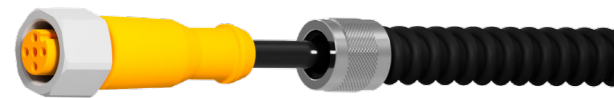

End Connection

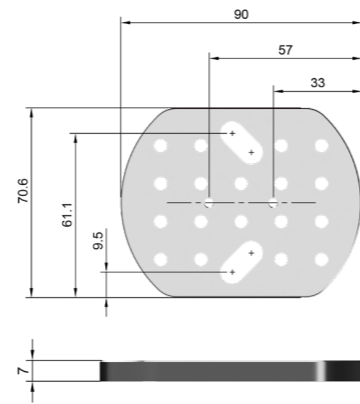

Mounting Bracket

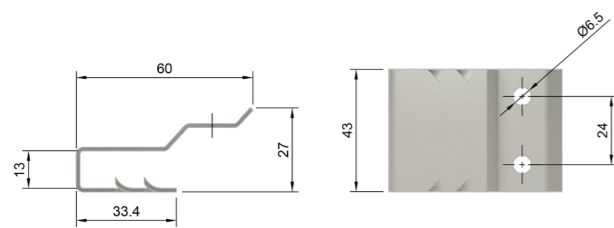

Track Clip

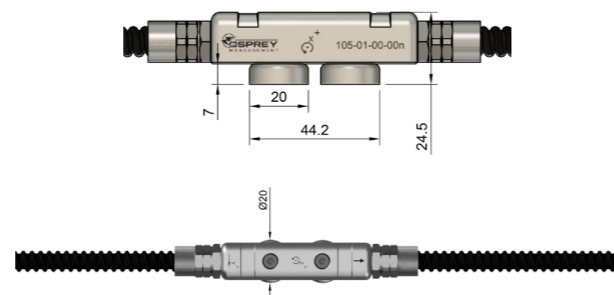

Magnets

## SPECIFICATIONS - PERFORMANCE

Dimensions	60 x 16 x 16mm		
Housing Material	Stainless Steel 316L		
Range	360°		
Resolution	±0.001mrad		
Repeatability	0.07mrad		
Accuracy (offset from vertical) <sup>1</sup>	±5°	±10°	±90°
	0.3mRad	0.5mRad	1mRad
Power Supply	4-24VDC		
Power Consumption (12V) <sup>2</sup>	Boot	Idle	Measure
	210ms@30mA	0.5A to 0.5mA	200mS@20mA
Communication	RS485, Modbus RTU Compatible		

<sup>1</sup> Stated to 2 sigma

<sup>2</sup> Boot and measure are user configurable to be parallel or sequential

## SPECIFICATIONS - PHYSICAL

Node Body Material	Stainless steel 316L
Node Dimensions	70 x 17.5 x 17.5mm
Node Weight	123g
Cable - Kevlar	4 x 0.28mm <sup>2</sup> , 7mm jacket 51g/m
Cable - Standard	4 x 0.5mm <sup>2</sup> , 6mm R-118 compliant PUR Jacket, 40g/m
Armoured Conduit	10 x 6.8mm, galvanized steel coated in black LSZH 125g/m
Flexible Conduit	10 x 6.3mm corrugated black FPAS10B, flame retardant LSZH PA6, 18g/m

## SPECIFICATIONS - ACCESSORIES

	Dimensions	Weight	Materials
Rail Clip - BS110, BS113	43 x 60 x 27mm	45g per clip	Passivated spring steel
Mounting Bracket	90 x 70.6 x 7mm	276g	Stainless steel 316
Fixing Straps	6.4 x 0.5 x adjustable	25g per meter	Stainless steel 201
Magnets	20 x 20 x 24.5mm	15g ea, 15kg total pull force	N42 Neodymium



Osprey Tilt String (OTS)  
Product Data Sheet

Osprey Measurement Systems International Ltd  
6-11 Bluebell Business Estate,  
Sheffield Park, East Sussex  
TN22 3HQ  
+44 (0) 20 3355 4447  
[info@ospreymeasurement.com](mailto:info@ospreymeasurement.com)